

# 622/632

## 622/623-Series

### SMALL-SIZED ROCKER SWITCHES

A high powered offering packed into a small-sized envelope, the 622/632-Series is a staple of numerous markets. With its silver-alloy butt contacts, the 622/632 will handle inrush spikes up to 100 amps and steady state current to 12A 125VAC. The lighted 632-Series features a multitude of illumination circuit options available with LED, incandescent and neon style lamps.



#### Product Highlights:

- ♦ Illuminated or Non-Illuminated
- ♦ Silver Plated Butt contacts that handle high Inrush spikes
- ♦ Independent or Dependent lamp circuitry
- ♦ Industry standard size mounting hole

#### Typical Applications:

- ♦ Appliance
- ♦ Food Service
- ♦ Transportation
- ♦ General Purpose



### Dielectric Strength

UL/CSA:  
1000V-live to dead metal parts  
& opposite polarity

### Electrical Life

50,000 cycles

### Mechanical Life

100,000 cycles

### Operating Temperature

32°F to 185°F (0°C to 85°C)

**632121 - 1 B - K N**

1 Base Part Number

2 Actuator Color

3 Base Color

4 Lamp

5 Legend

#### BASE PART NUMBER: SERIES / CIRCUITRY / RATING / TERMINATION

8A 250VAC; 12A 125VAC; 1/2 HP 125-250VAC  
622-SERIES NON-ILLUMINATED ROCKER

ON-none-OFF (Single Pole)  
ON-none-OFF (Double Pole)

#### 632-SERIES ILLUMINATED ROCKER

ON-none-OFF (Single Pole, dependent lamp) schematic 1  
ON-none-OFF (Single Pole, independent lamp) schematic 3  
ON-none-OFF (Single Pole, independent lamp unballasted) schematic 5  
ON-none-OFF (Double Pole, dependent lamp with 5 terms.) schematic 2  
ON-none-OFF (Double Pole, dependent lamp with 4 terms.) schematic 4

Solder Lugs .187 Tabs

622121 622122  
622221 622222

632121 632122  
632321 632322  
632521 632522  
632221 632222  
632421 632422

#### 3 ACTUATOR COLOR<sup>3</sup>

622 (non illuminated)

B Black  
W White

632 (illuminated)

1 Clear Amber  
2 Clear Red  
3 Clear Blue<sup>2</sup>  
4 Clear Green  
5 Clear

#### 4 LAMP VOLTAGE / STYLE<sup>1</sup>

N 622 (non illuminated)  
1 unballasted LED  
2 6V LED  
3 12V LED  
4 24V LED

A 6V incandescent  
C 12V incandescent  
E 18V incandescent  
H 24V incandescent  
J 125V neon  
K 250V neon

#### 3 BASE COLOR<sup>3</sup>

B Black

W White

#### 5 ROCKER LEGEND

N NO Legend  
A OFF-ON vertical  
B OFF-ON horizontal  
D I-O horizontal  
E I-O vertical  
F O on rocker radius

#### Notes:

- For all incandescent or LED lamps specify 5 in 5th digit of part number. Example 632151-1B-CN
- Available with incandescent lamps only.
- Additional colors available. Consult factory for details.

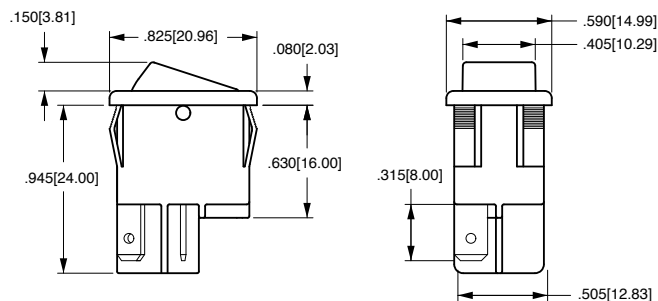

#### 632 SCHEMATIC

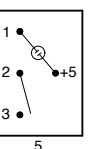
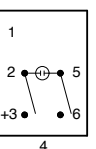
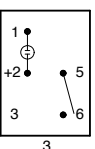
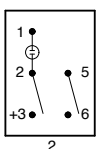
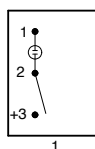

#### UNBALLASTED

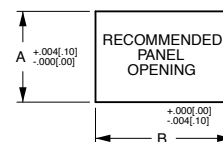
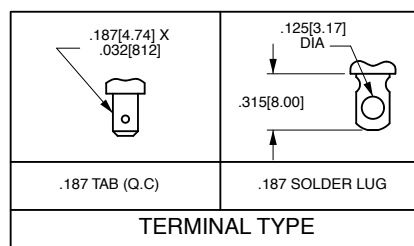

PANEL THICKNESS	A	B
.030[.76]-.050[1.27]	.508[12.90]	.756[19.20]
.050[1.27]-.078[1.98]	.508[12.90]	.764[19.40]
.078[1.98]-.125[3.17]	.508[12.90]	.780[19.81]

\*Manufacturer reserves the right to change product specification without prior notice.

## Authorized Sales Representatives and Distributors

Click on a region of the map below to find your local representatives and distributors or visit [www.carlingtech.com/findarep](http://www.carlingtech.com/findarep).



## About Carling

Founded in 1920, Carling Technologies is a leading manufacturer of electrical and electronic switches and assemblies, circuit breakers, electronic controls, power distribution units, and multiplexed power distribution systems. With four ISO registered manufacturing facilities and technical sales offices worldwide, Carling Technologies Sales, Service and Engineering teams do much more than manufacture electrical components, they engineer powerful solutions! To learn more about Carling please visit [www.carlingtech.com/company-profile](http://www.carlingtech.com/company-profile).

To view all of Carling's environmental, quality, health & safety certifications please visit [www.carlingtech.com/environmental-certifications](http://www.carlingtech.com/environmental-certifications)

## **Worldwide Headquarters**

Carling Technologies, Inc.  
60 Johnson Avenue, Plainville, CT 06062  
**Phone:** 860.793.9281 **Fax:** 860.793.9231  
**Email:** sales@carlingtech.com

**Northern Region Sales Office:** nrsm@carlingtech.com  
**Southeast Region Sales Office:** sersm@carlingtech.com  
**Midwest Region Sales Office:** mrrsm@carlingtech.com  
**West Region Sales Office:** wrsm@carlingtech.com  
**Latin America Sales Office:** larsm@carlingtech.com

## **Asia-Pacific Headquarters**

Carling Technologies, Asia-Pacific Ltd.,  
Suite 1607, 16/F Tower 2, The Gateway,  
Harbour City, 25 Canton Road,  
Tsimshatsui, Kowloon, Hong Kong  
**Phone:** Int + 852-2737-2277 **Fax:** Int + 852-2736-9332  
**Email:** sales@carlingtech.com.hk

**Shenzhen, China:** shenzhen@carlingtech.com  
**Shanghai, China:** shanghai@carlingtech.com  
**Pune, India:** india@carlingtech.com  
**Kaohsiung, Taiwan:** taiwan@carlingtech.com  
**Yokohama, Japan:** japan@carlingtech.com

## **Europe | Middle East | Africa Headquarters**

Carling Technologies LTD  
4 Airport Business Park, Exeter Airport,  
Clyst Honiton, Exeter, Devon, EX5 2UL, UK  
**Phone:** Int + 44 1392.364422 **Fax:** Int + 44 1392.364477  
**Email:** ltd.sales@carlingtech.com

**Germany:** gmbh@carlingtech.com  
**France:** sas@carlingtech.com



**Carling Technologies®**

Innovative Designs. Powerful Solutions.